

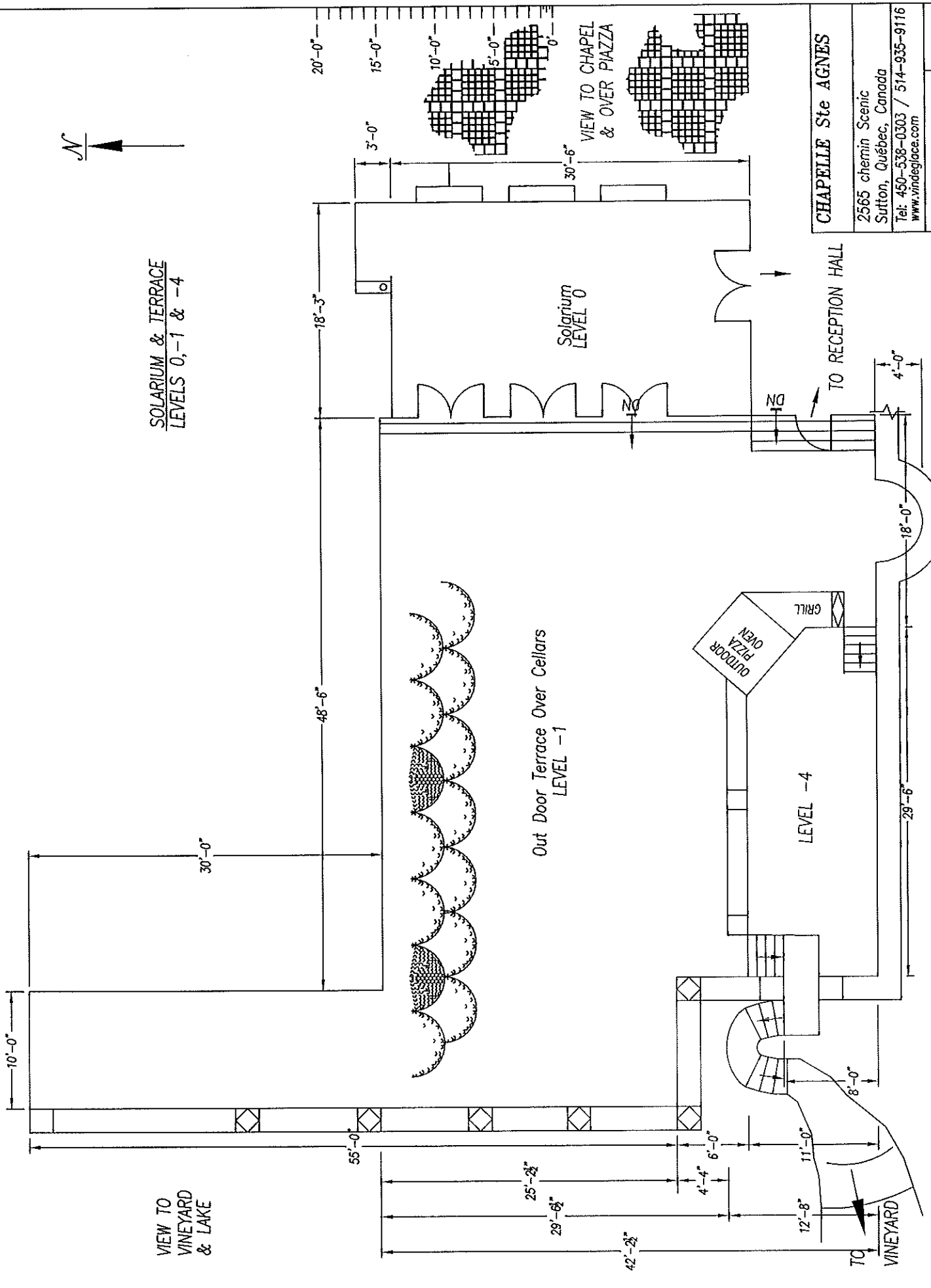

SOLARIUM & TERRACE  
LEVELS 0, -1 & -4



CHAPELLE Ste AGNES  
2565 chemin Scenic  
Sutton, Québec, Canada  
Tel: 450-538-0303 / 514-935-9116  
www.vindeglace.com

SOLARIUM + TERRACE A



SOLARIUM : Buffet  
 OUT DOOR TERRACE : 10 TABLES X 8 PEOPLE = 80  
 TOTAL = 80

SOLARIUM & TERRACE  
 LEVELS 0, -1 & -4

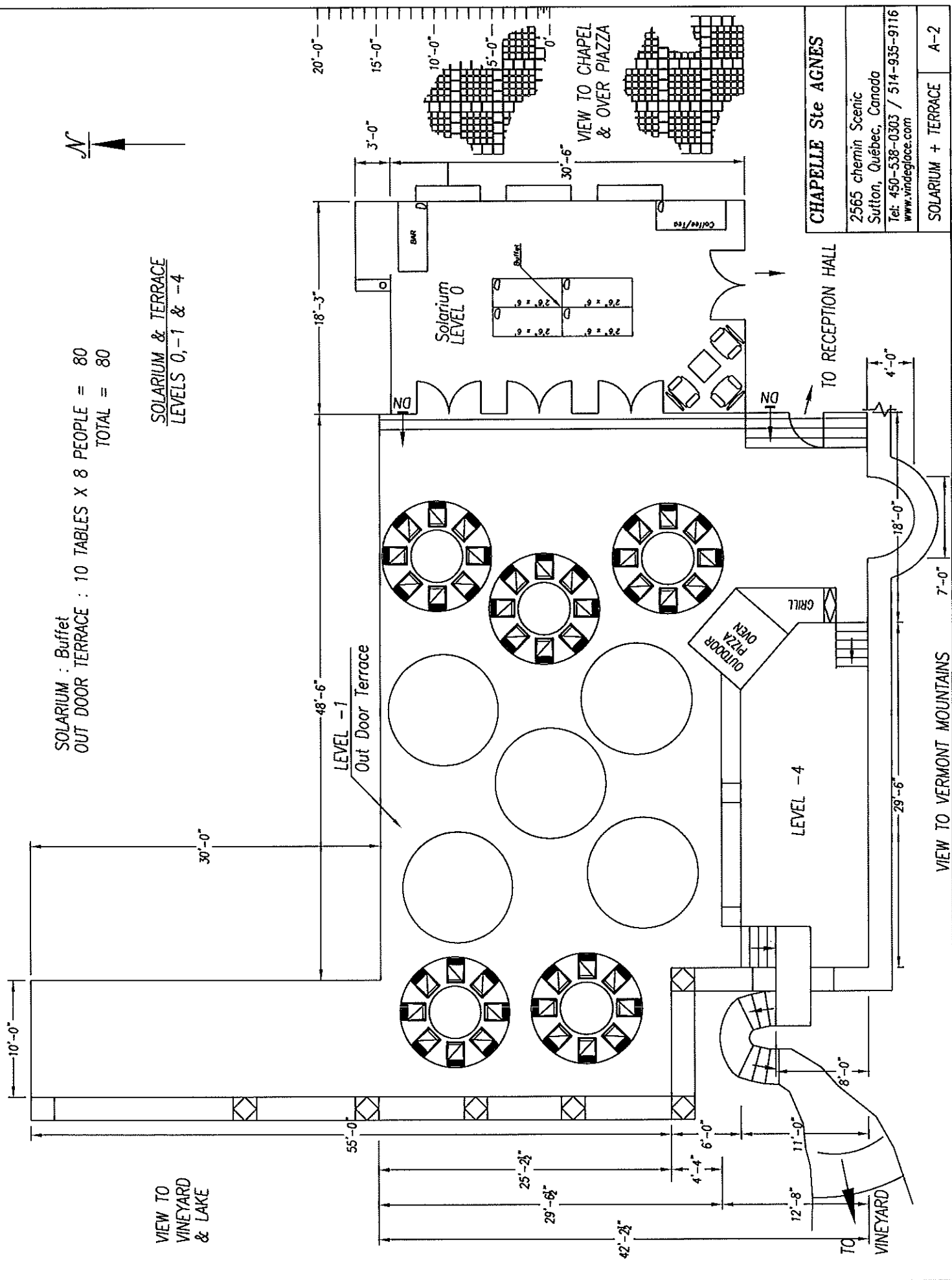

**CHAPELLE Ste AGNES**  
 2565 chemin Scenic  
 Sutton, Québec, Canada  
 Tel: 450-538-0303 / 514-935-9116  
 www.vindeglace.com

SOLARIUM + TERRACE A-2

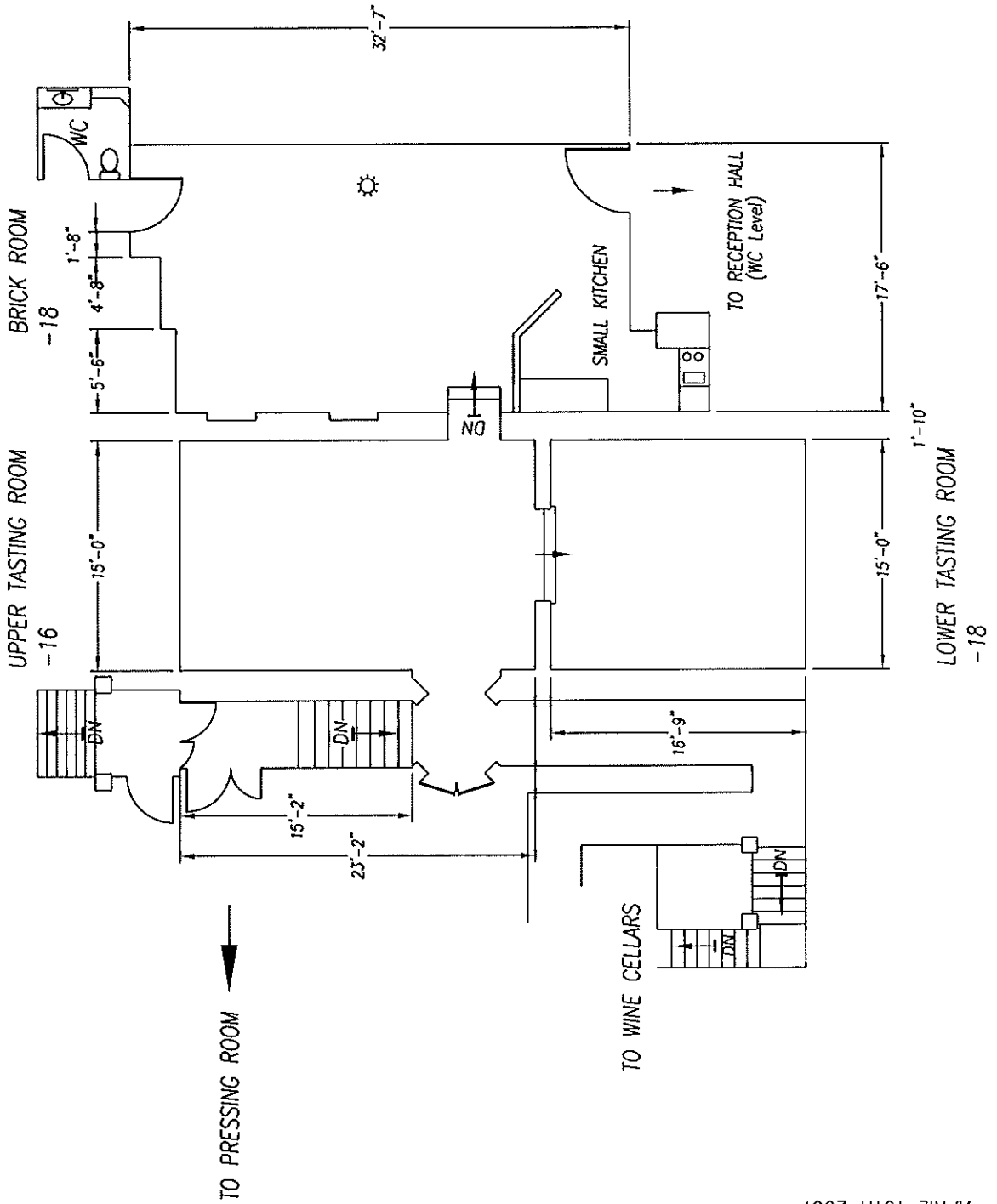

<b>CHAPELLE Ste AGNES</b>	
2565 chemin Scenic Sutton, Québec, Canada	
Tel: 450-538-0303 / 514-935-9116 www.vindegloce.com	
TASTING ROOMS	B



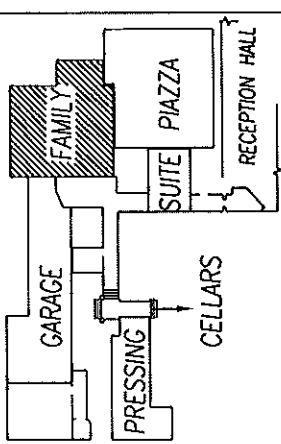
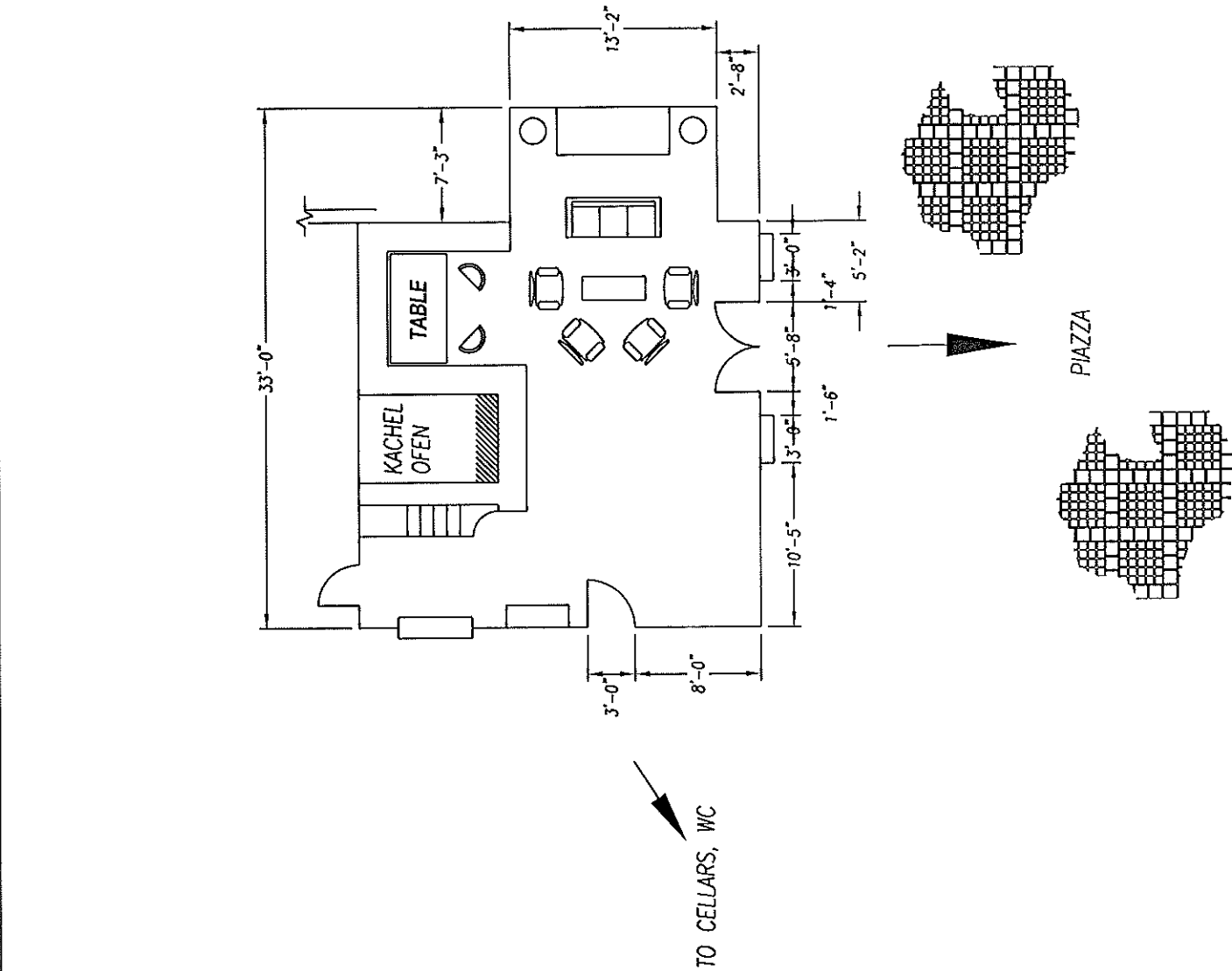

FAMILY ROOM  
LEVEL -9

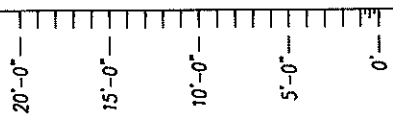

<b>CHAPELLE Ste AGNES</b>	
2565 chemin Scenic Sutton, Québec, Canada	
Tel: 450-538-0303 / 514-935-9116 www.vindegloce.com	
FAMILY ROOM	C

TO VINEYARDS

TO TASTING ROOMS, BRICK ROOM, CELLARS

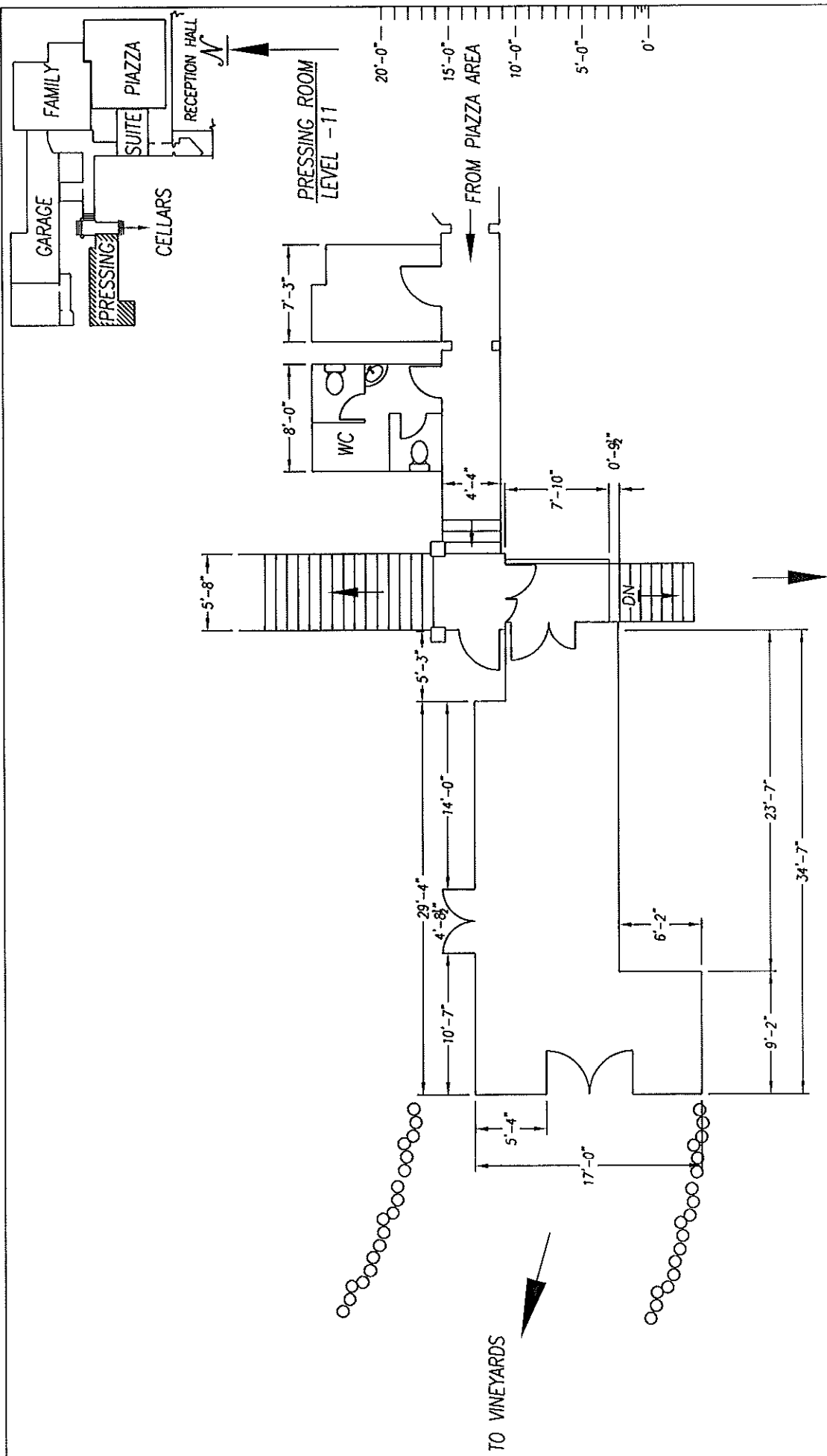

<b>CHAPELLE Ste AGNES</b>	
2565 chemin Scenic Sutton, Québec, Canada	
Tel: 450-538-0303 / 514-935-9116 www.vindeglace.com	
PRESSING ROOM	D

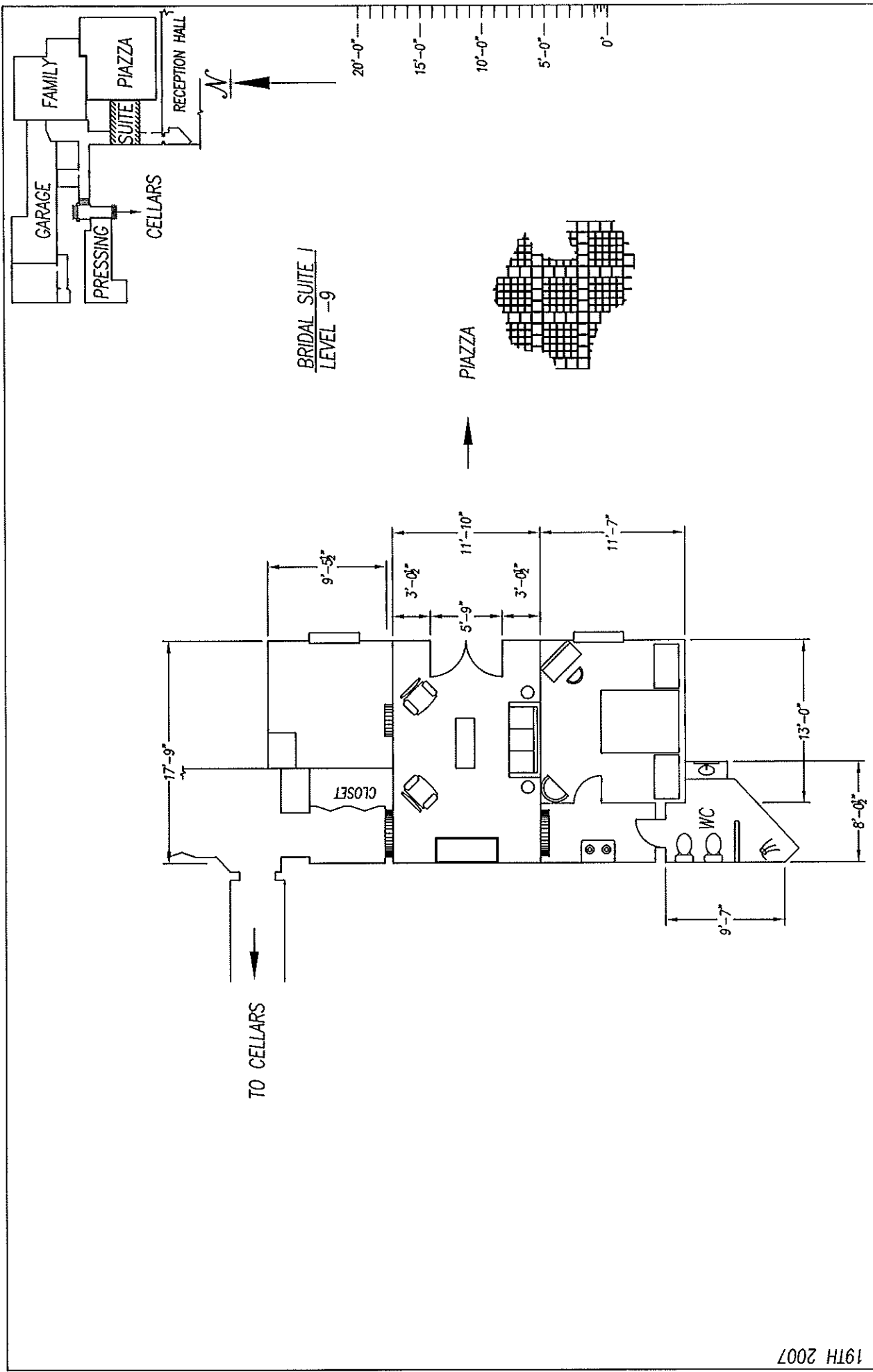

<b>CHAPELLE Ste AGNES</b>	
2565 chemin Scenic Sutton, Québec, Canada	
Tel: 450-538-0303 / 514-935-9116 www.vindeglace.com	
BRIDAL SUITE 1	E

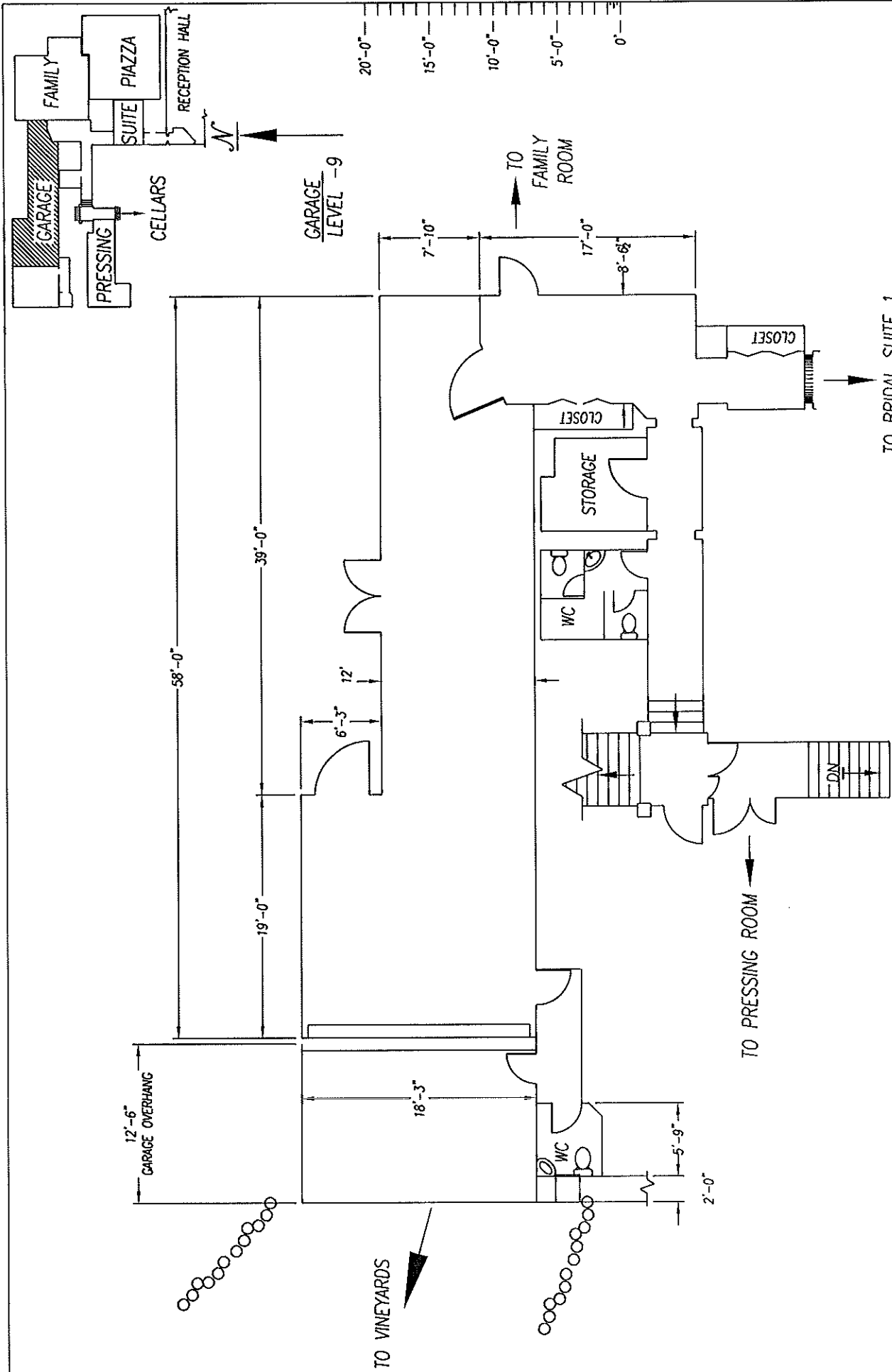

<b>CHAPELLE Ste AGNES</b>	
2565 chemin Scenic Sutton, Québec, Canada	
Tel: 450-538-0303 / 514-935-9116 www.vindeglace.com	
GARAGE	F

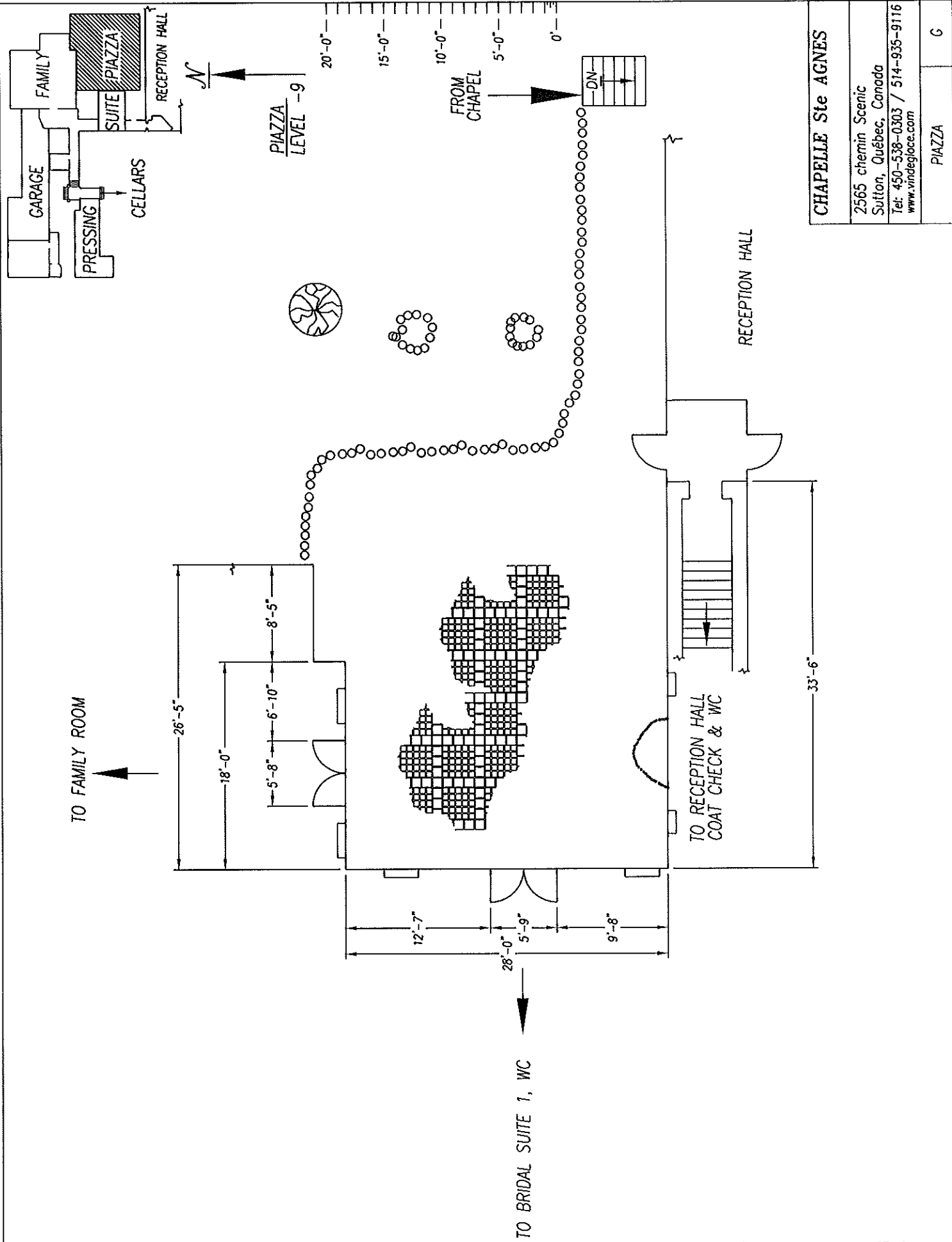

<b>CHAPELLE Ste AGNES</b>	
2565 chemin Scenic Sutton, Québec, Canada	
Tel: 450-538-0303 / 514-935-9116 www.vindeglace.com	
PIAZZA	G



20'-0"  
15'-0"  
10'-0"  
5'-0"  
0'-0"

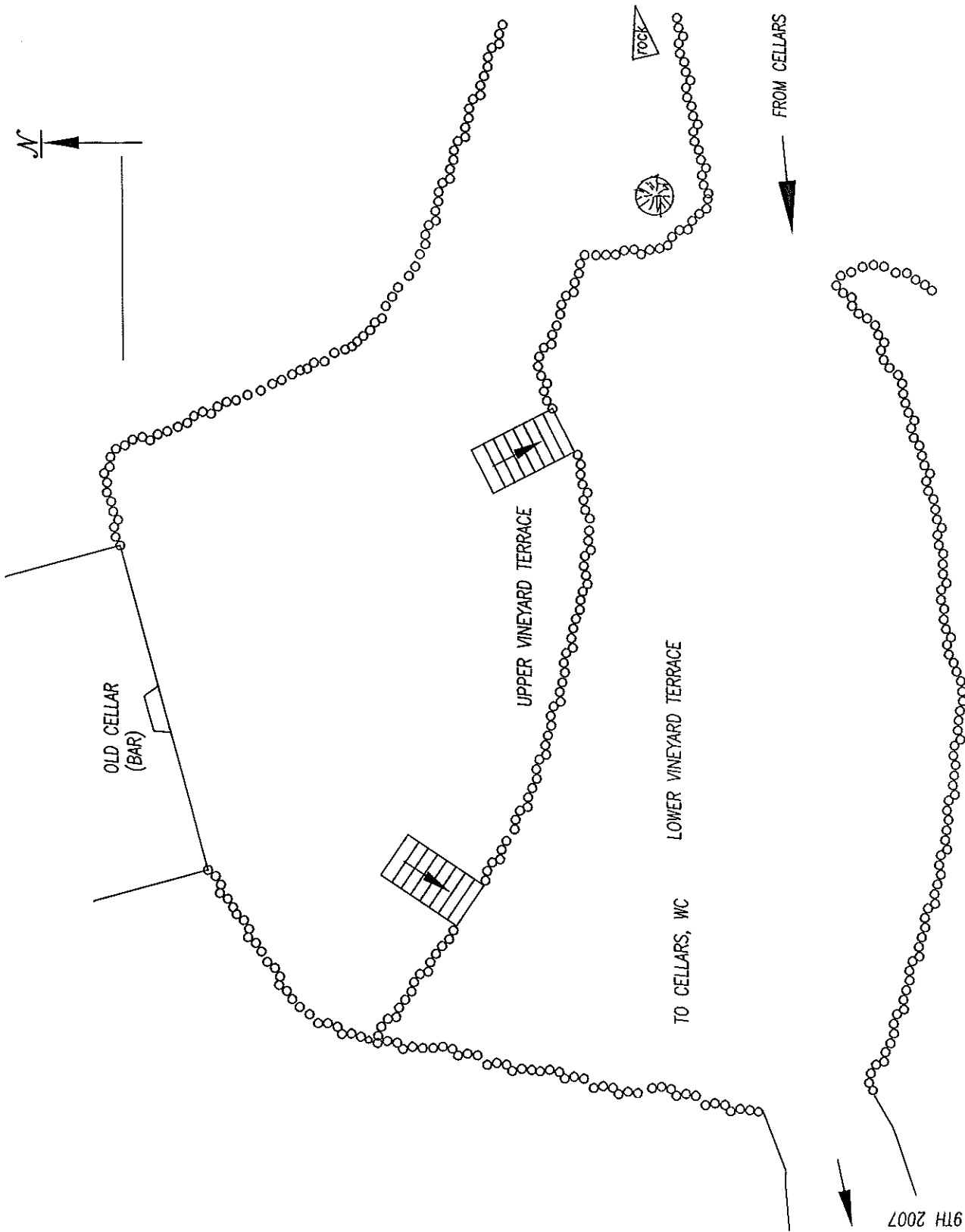

FROM CELLARS

TO LOWER VINEYARD  
SAUNA AND LAKE

ROAD THROUGH  
VINEYARD

APPROVED - APRIL 19TH 2007

APPROVED - APRIL 19TH 2007

CHAPELLE Ste AGNES

2565 chemin Scenic  
Sutton, Québec, Canada  
Tel: 450-538-0303 / 514-935-9116  
www.vindeglace.com

VINEYARD TERRACES  
I-1

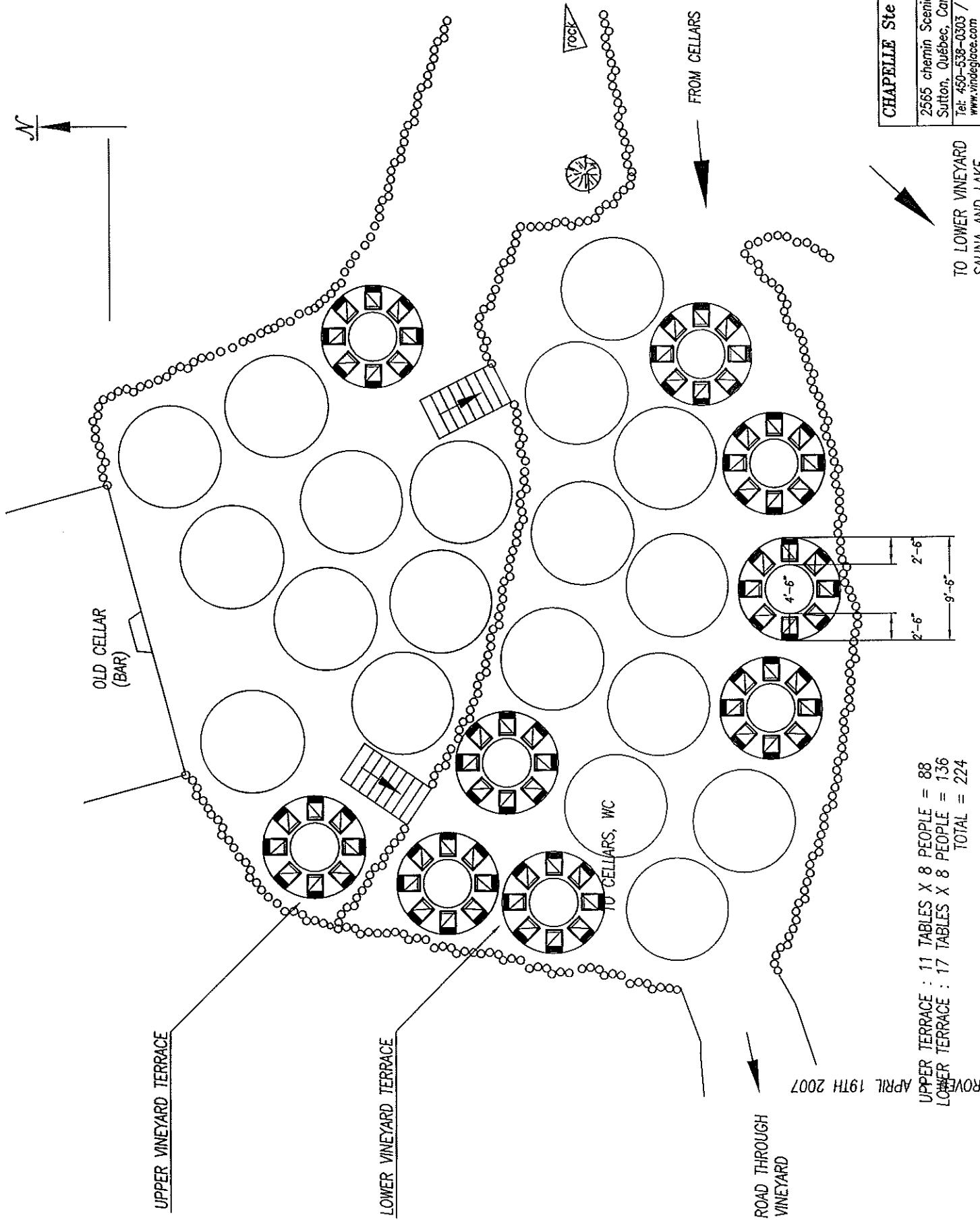
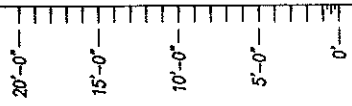

**CHAPELLE Ste AGNES**  
 2565 chemin Scenic  
 Sutton, Québec, Canada  
 Tel: 450-538-0303 / 514-935-9116  
 www.vindeglace.com

APPROVED - APRIL 19TH 2007  
 UPPER TERRACE : 11 TABLES X 8 PEOPLE = 88  
 LOWER TERRACE : 17 TABLES X 8 PEOPLE = 136  
 TOTAL = 224

APPROVED - APRIL 19TH 2007

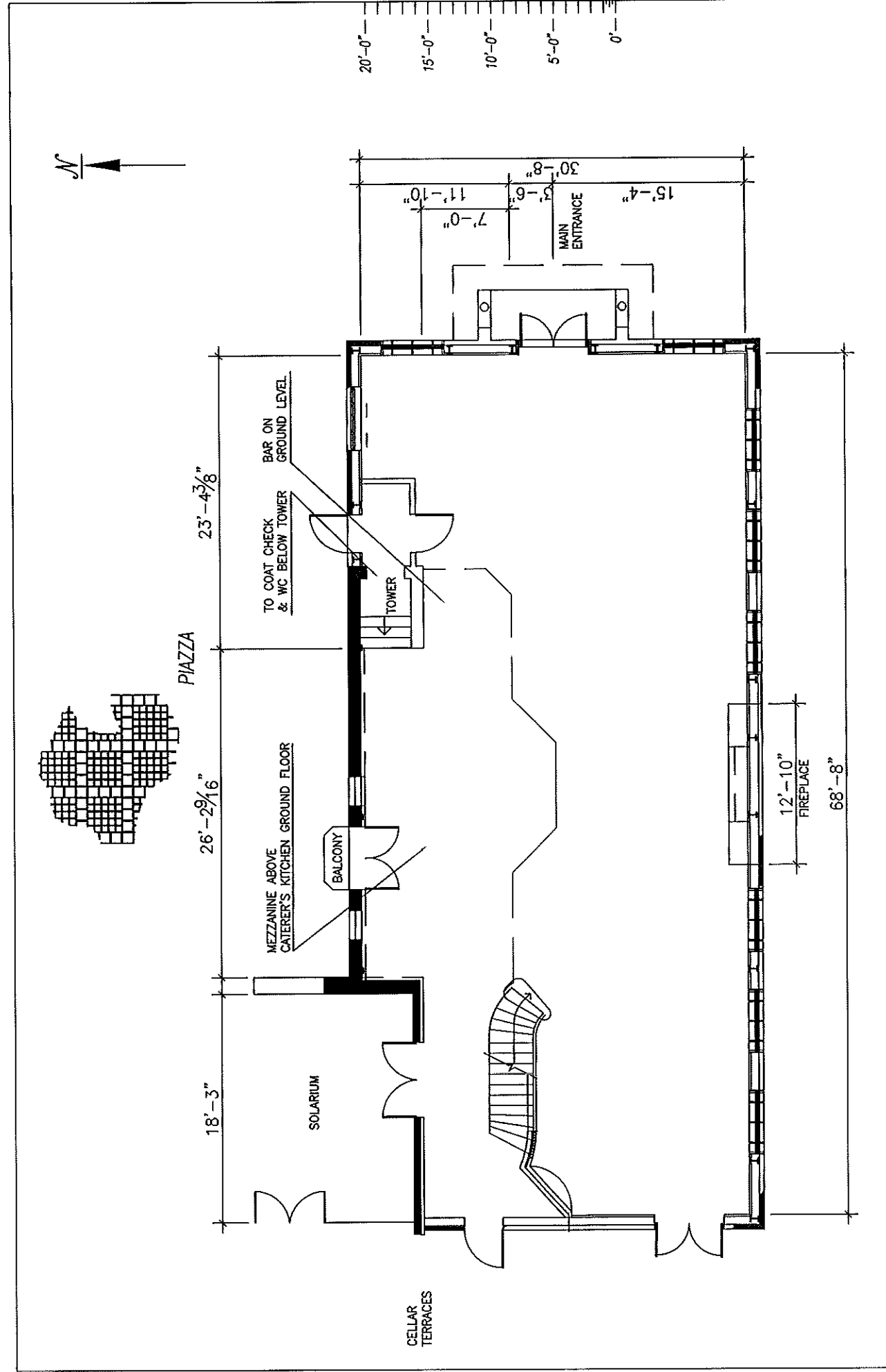

<b>CHAPELLE Ste AGNES</b>	
2565 chemin Scenic Sutton, Québec, Canada	
Tel: 450-538-0303 / 514-935-9116 www.vindeglace.com	
RECEPTION HALL	J

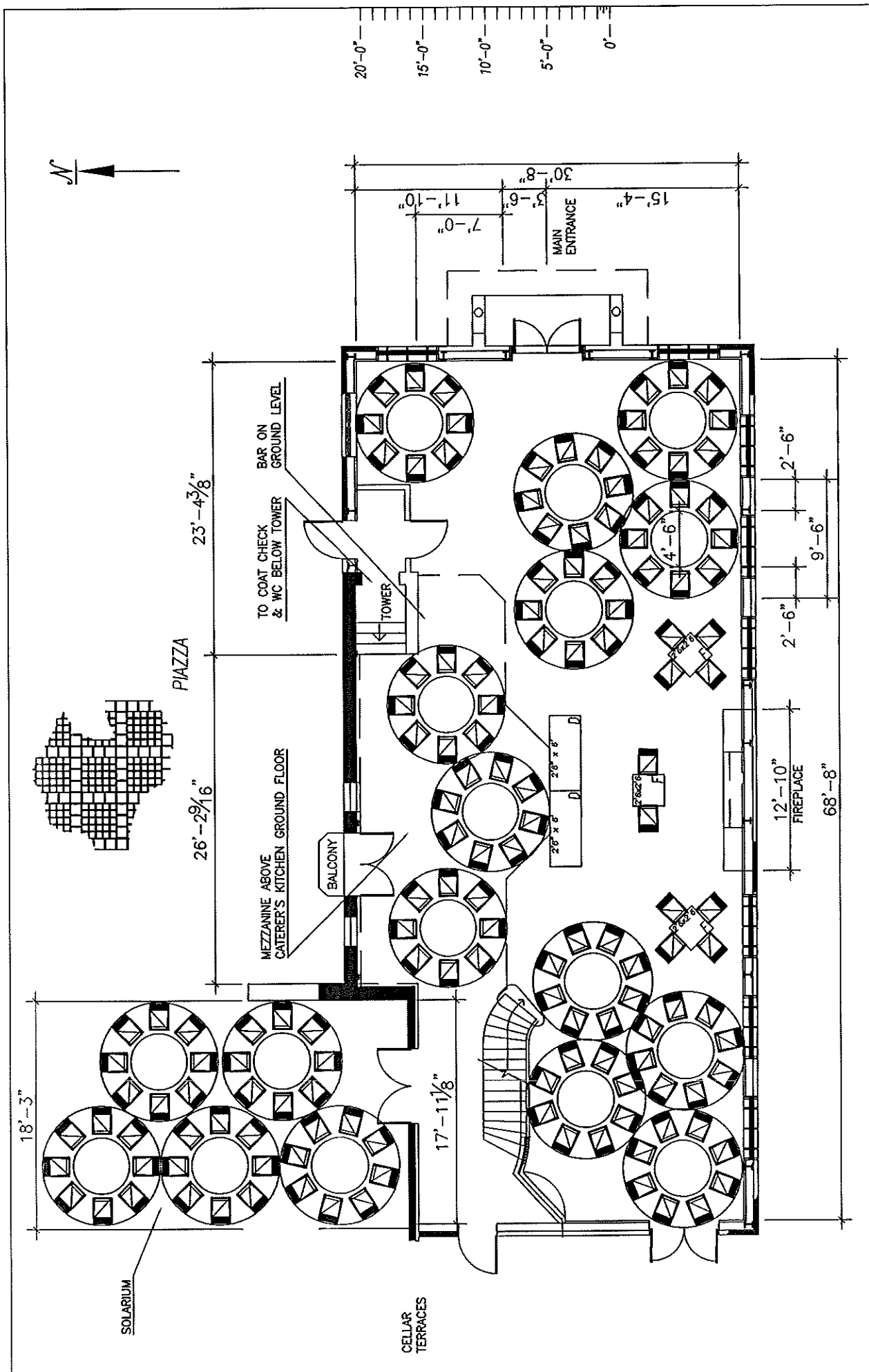

**CHAPELLE Ste AGNES**  
 2565 chemin Scenic  
 Sutton, Québec, Canada  
 Tel: 450-538-0303 / 514-935-9116  
 www.vindeglace.com

RECEPTION HALL J-1B

Grand Floor : 9 Tables x 8 People, 2 Tables x 4, (1 Table x 2) = 80 ( 82)  
 Mezzanine : 3 Tables x 8 People = 24  
 Solarium 5 Tables x 8 People = 40  
 Total = 144 (146)

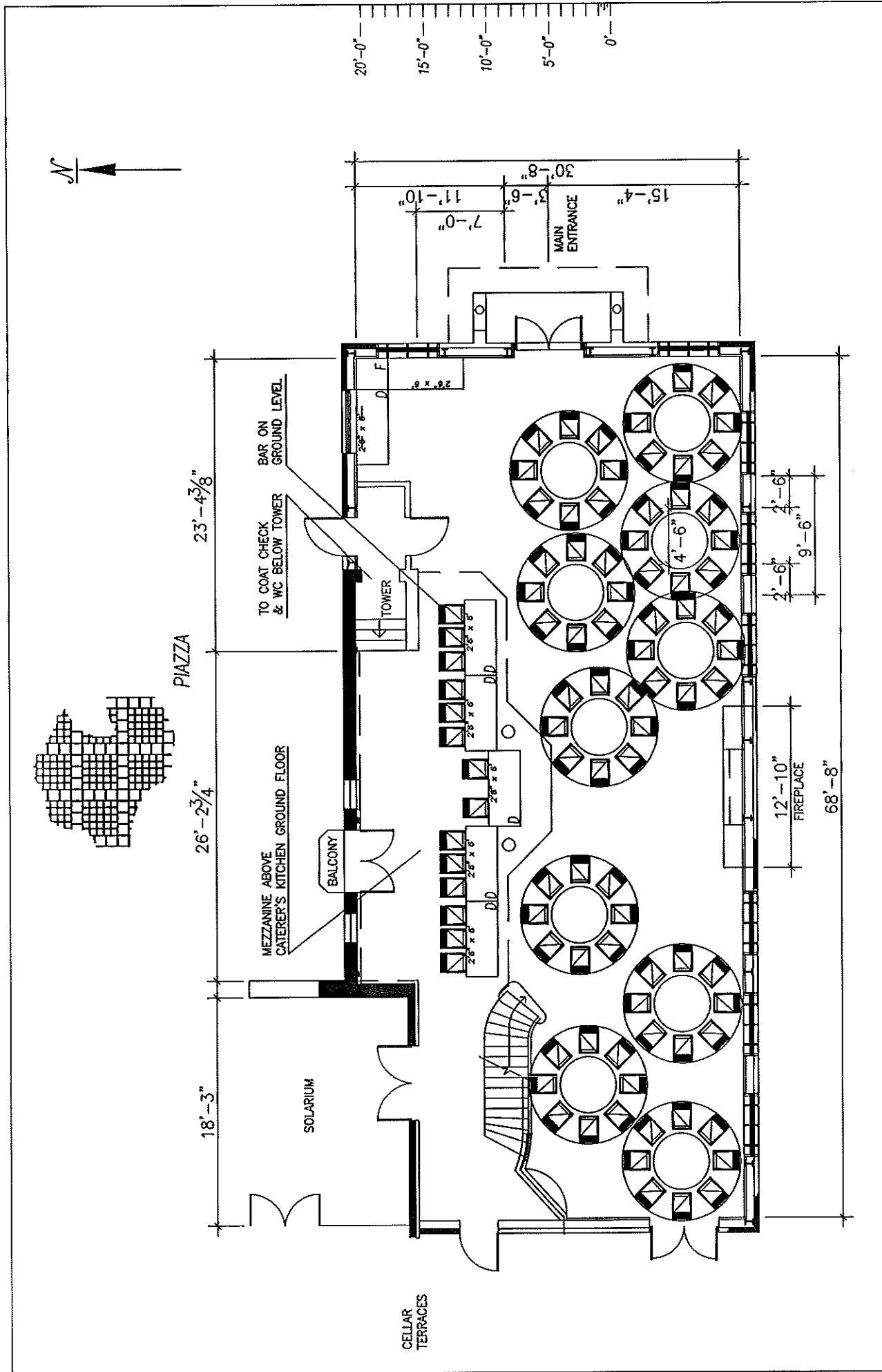

<b>CHAPELLE Ste AGNES</b>	
2565 chemin Scenic Sutton, Québec, Canada	
Tel: 450-538-0303 / 514-935-9116 www.vindeglace.com	
RECEPTION HALL	J-2

Grand Floor : 10 Tables x 8 People = 80  
 Mezzanine : Head Table = 14  
 Total = 94

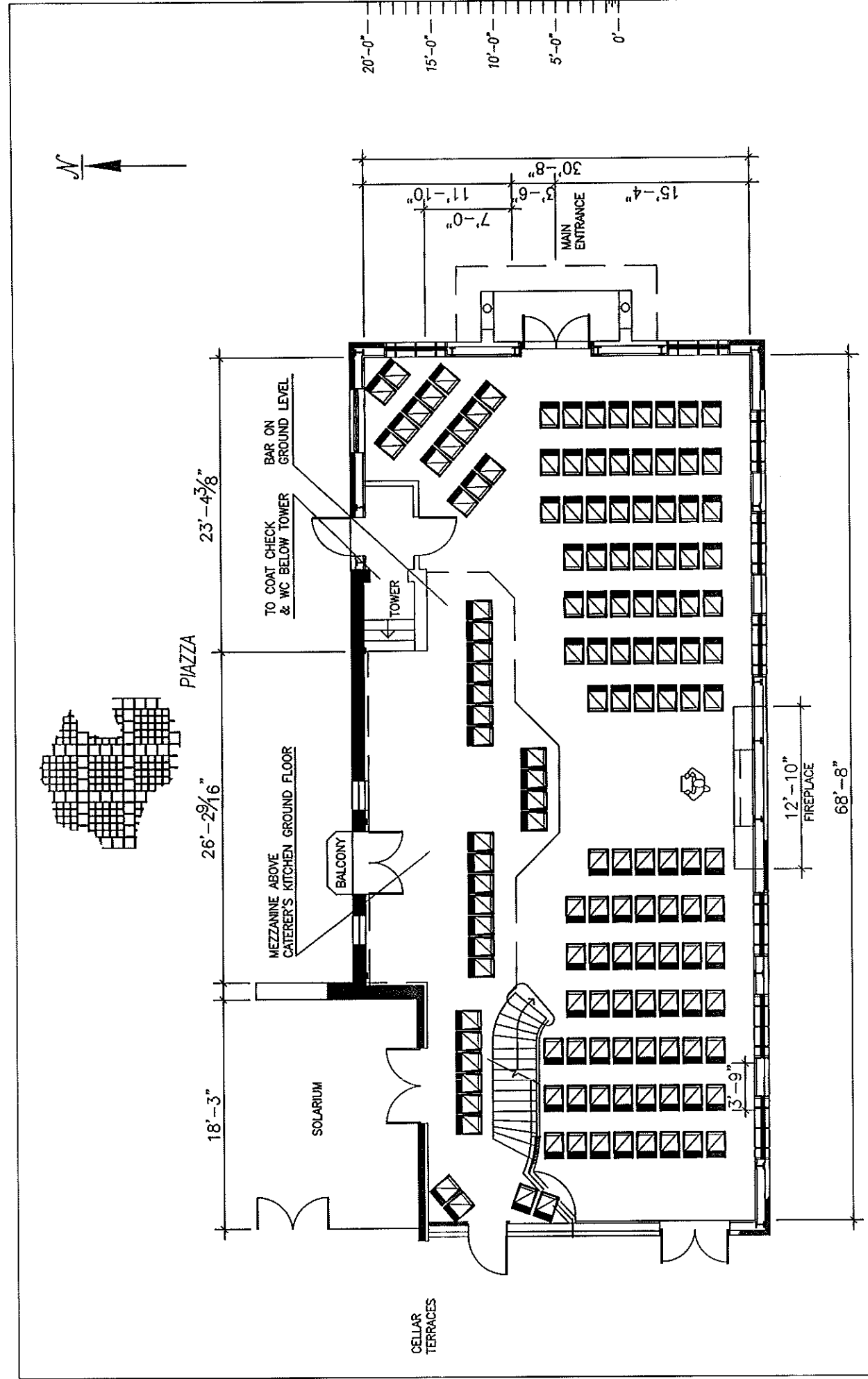

<b>CHAPELLE Ste AGNES</b>	
2565 chemin Scenic Sutton, Québec, Canada	
Tel: 450-538-0303 / 514-935-9116 www.vindeglace.com	
RECEPTION HALL	J-5A

Theatre Style  
 Grand Hall : 117  
 Mezzanine : 28  
 145

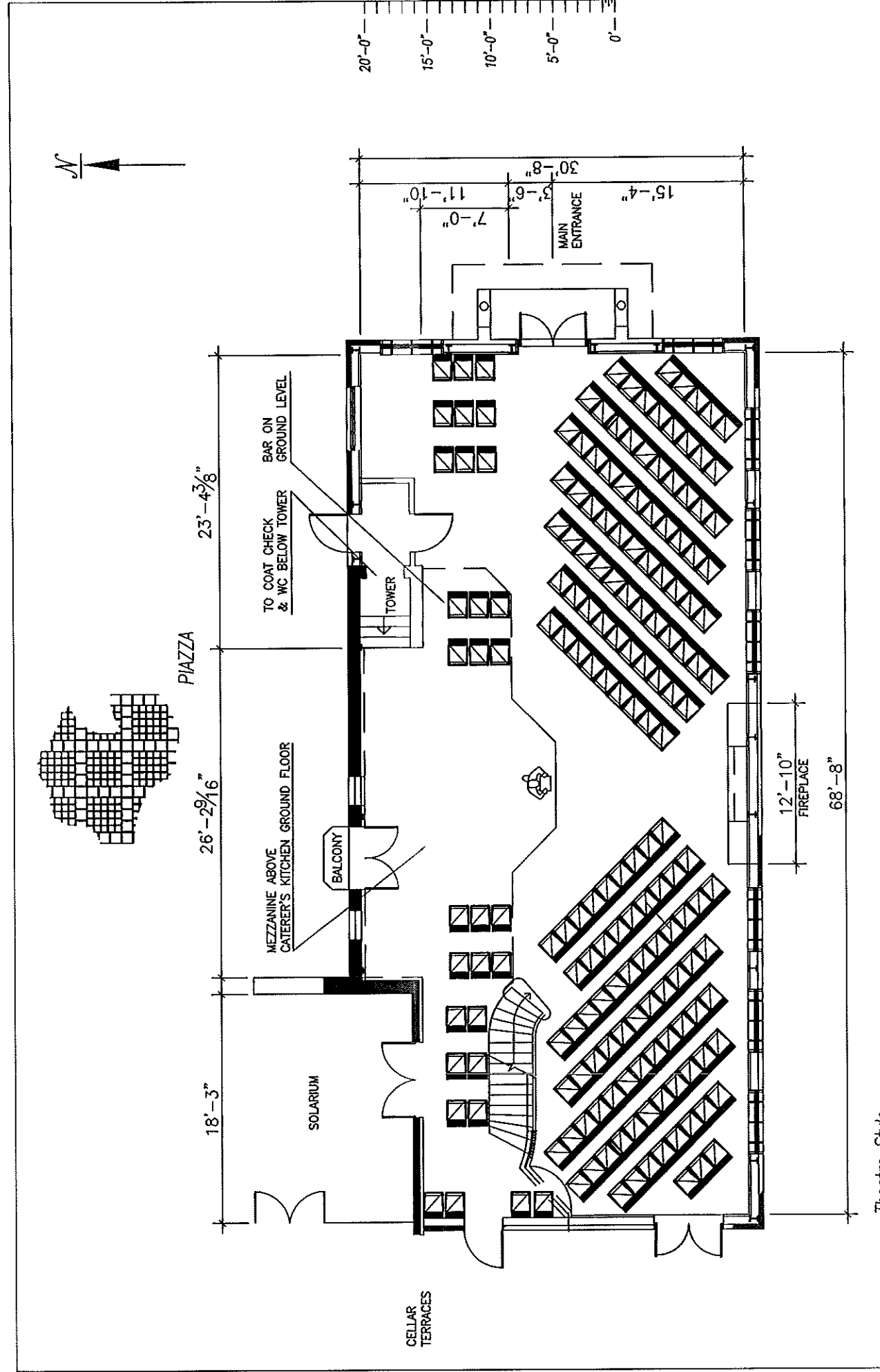

<b>CHAPELLE Ste AGNES</b>	
2565 chemin Scenic Sutton, Québec, Canada Tel: 450-538-0303 / 514-935-9116 www.vindeglace.com	
RECEPTION HALL	J-5B

Theatre Style  
 Grand Hall : 160  
 Mezzanine : 22  
 182

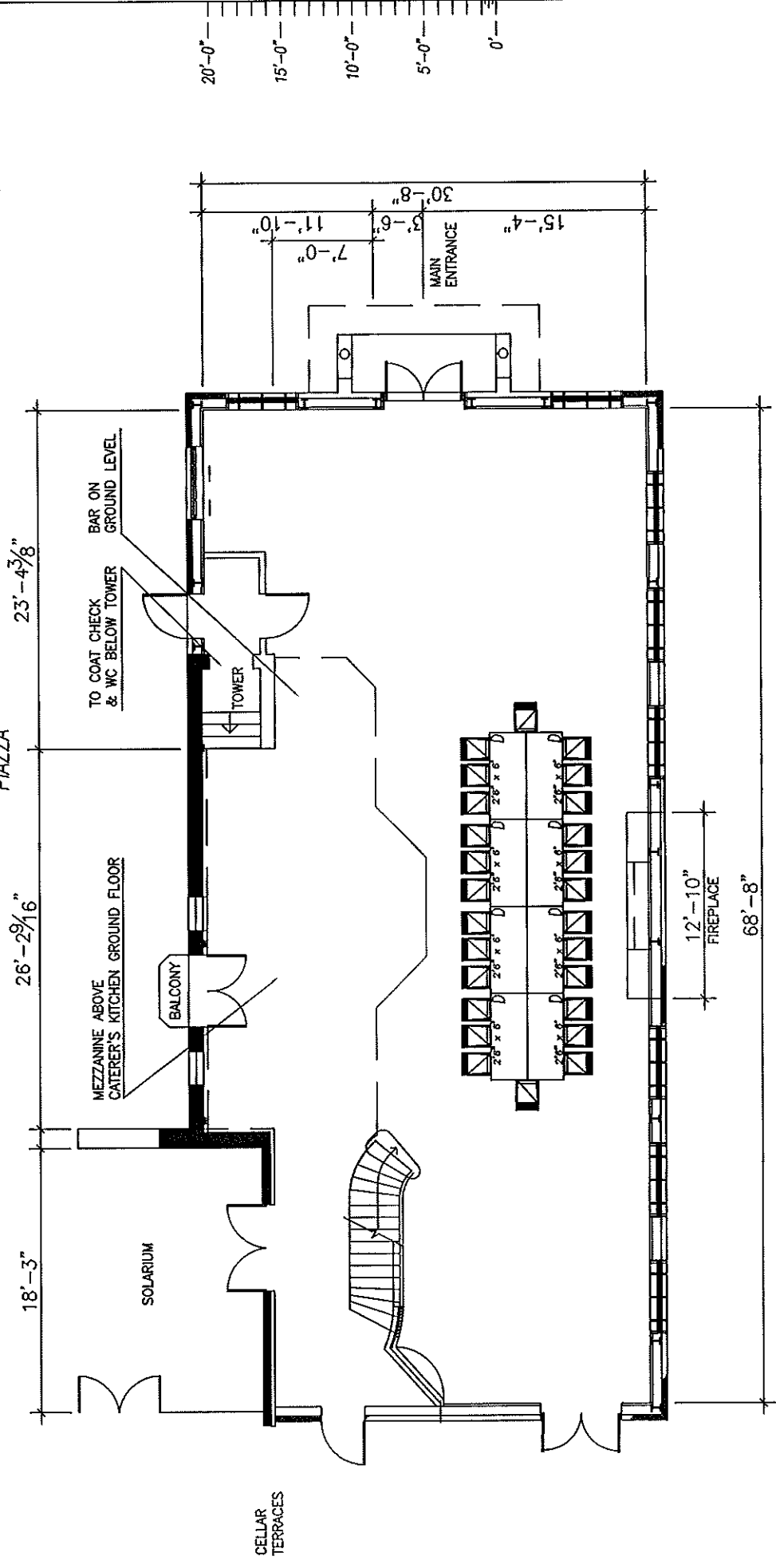
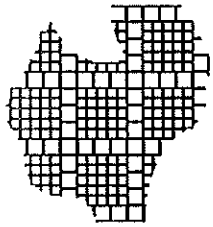

Formal Dinner / Meeting Style  
26 Seats

<b>CHAPELLE Ste AGNES</b>	
2565 chemin Scenic Sutton, Québec, Canada	
Tel: 450-538-0303 / 514-935-9116 www.vindeglace.com	
RECEPTION HALL	J-6



SOLARIUM  
LEVEL 0

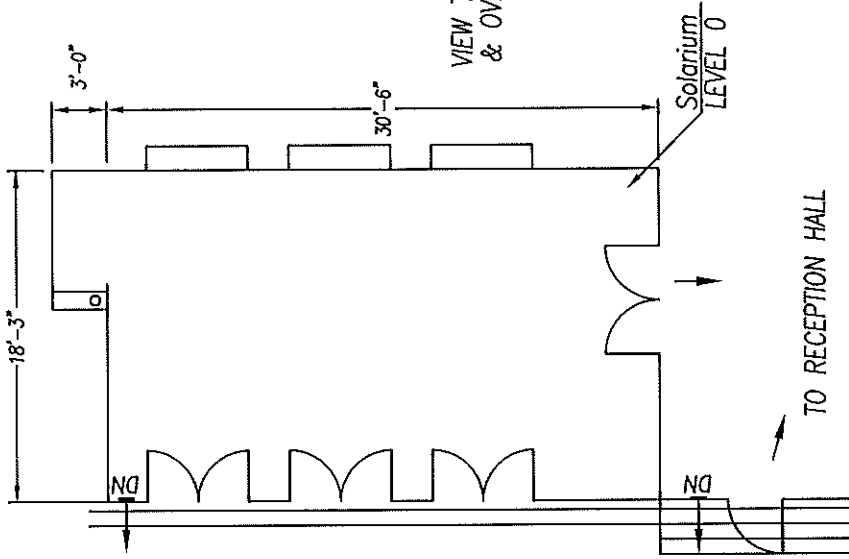

Out Door Terrace Over Cellars  
LEVEL -1

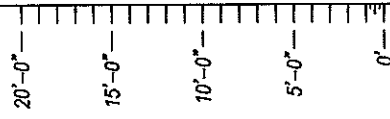

**CHAPELLE Ste AGNES**

2565 chemin Scenic  
Sutton, Québec, Canada  
Tel: 450-538-0303 / 514-935-9116  
www.vindeglace.com

SOLARIUM

K



SOLARIUM  
LEVEL 0

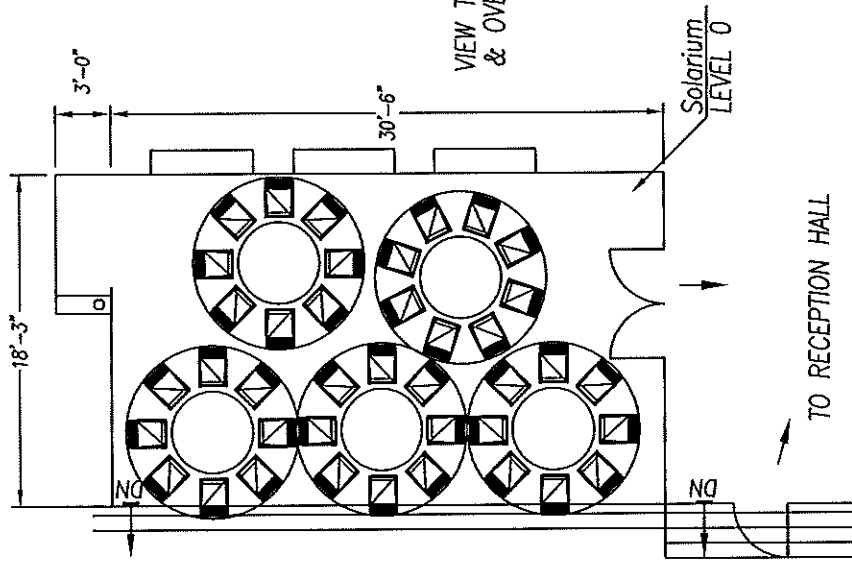

Out Door Terrace Over Cellars  
LEVEL -1

Banquet Style  
5 Tables x 8 People = 40

**CHAPELLE Ste AGNES**

2565 chemin Scenic  
Sutton, Québec, Canada  
Tel: 450-538-0303 / 514-935-9116  
www.vindeglace.com

SOLARIUM

K-1



SOLARIUM  
LEVEL 0

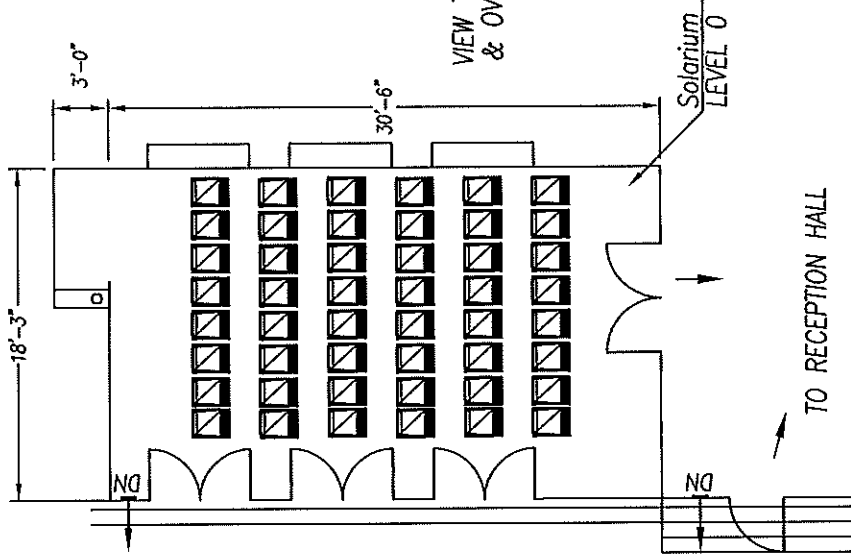

Out Door Terrace Over Cellars  
LEVEL -1

Theatre Style  
48 Seats

**CHAPELLE Ste AGNES**

2565 chemin Scenic  
Sutton, Québec, Canada  
Tel: 450-538-0303 / 514-935-9116  
www.vindeglace.com

SOLARIUM      K -3

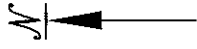

SOLARIUM  
LEVEL 0

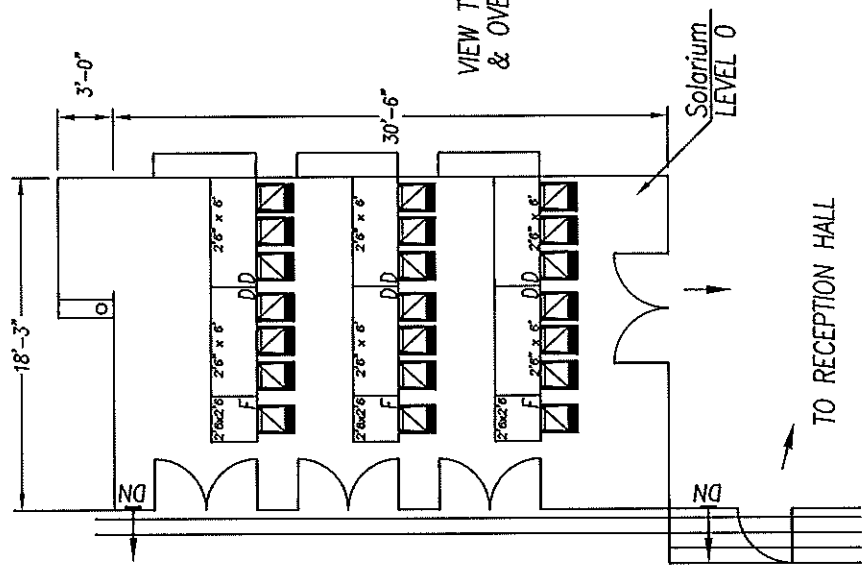

Out Door Terrace Over Cellars  
LEVEL -1

Class Room Style  
21 Seats

<b>CHAPELLE Ste AGNES</b>	
2565 chemin Scenic Sutton, Québec, Canada	
Tel: 450-538-0303 / 514-935-9116 www.vindegace.com	
<b>SOLARIUM</b>	<b>K - 4</b>

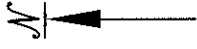

SOLARIUM  
LEVEL 0

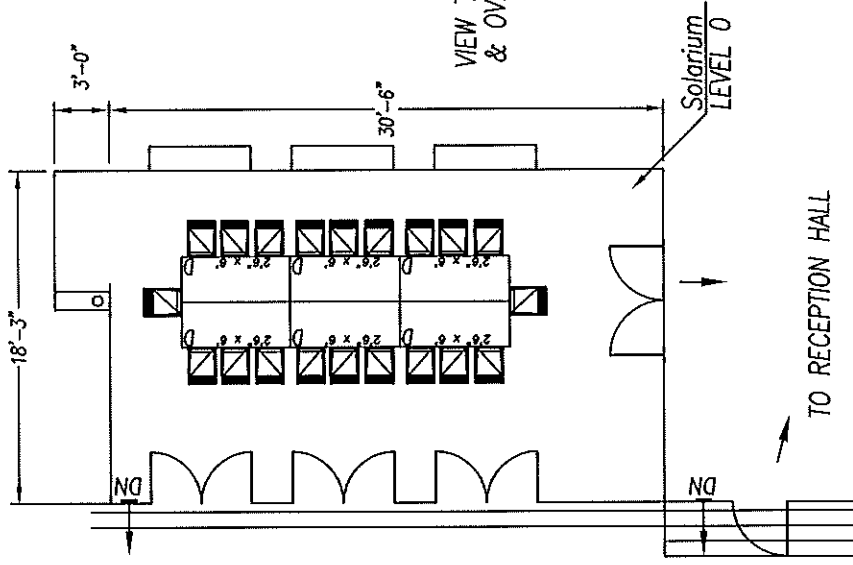

Out Door Terrace Over Cellars  
LEVEL -1

Meeting Style  
20 Seats

**CHAPELLE Ste AGNES**

2565 chemin Scenic  
Sutton, Québec, Canada  
Tel: 450-538-0303 / 514-935-9116  
www.vindeglace.com

SOLARIUM      K-5



SOLARIUM  
LEVEL 0

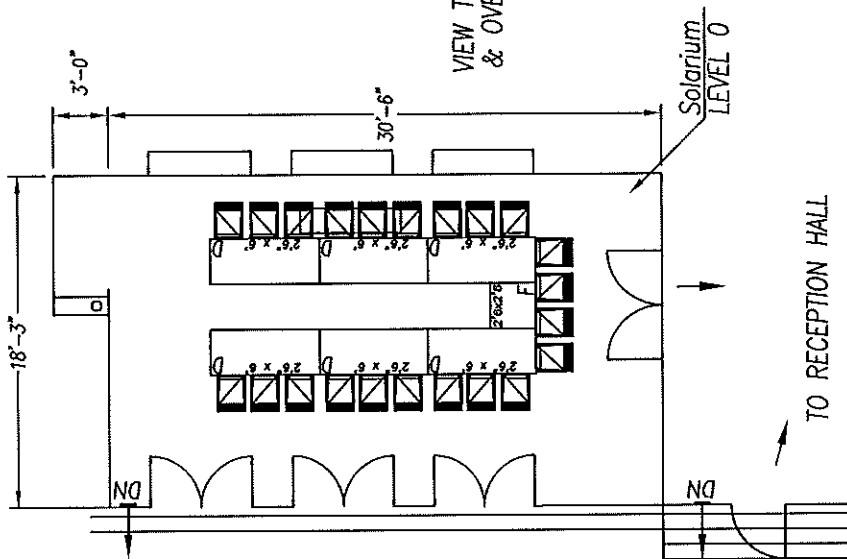

Out Door Terrace Over Cellars  
LEVEL -1

U-Shape Style  
22 Seats

**CHAPELLE Ste AGNES**

2565 chemin Scenic

Sutton, Québec, Canada

Tel: 450-538-0303 / 514-935-9116

www.vindeglace.com

SOLARIUM

K-6